

HYUNDAI
POWER PRODUCTS

ELECTRIC MOWER
HTDE1800-1

ORIGINAL INSTRUCTIONS



GENUINE PRODUCT OF
HYUNDAI CORPORATION

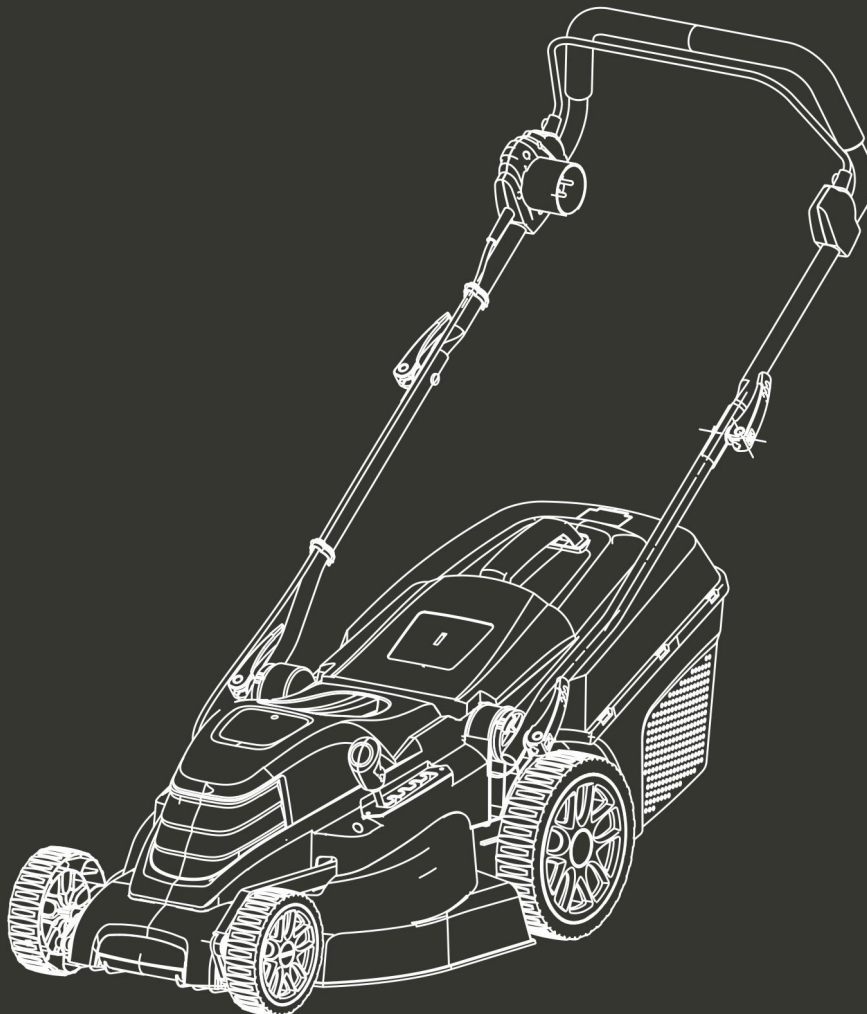

WARNING: Read thoroughly the instruction manual before use.

CONTENTS

1. GENERASAFETY INSTRUCTIONS.....	3
2. YOUR PRODUCT.....	9
3. ASSEMBLY.....	10
4. OPERATION.....	14
5. MAINTENANCE AND STORAGE.....	15
6. DECLARATION OF CONFORMITY.....	16
7. WARRANTY.....	17
8. PRODUCT FAILURE.....	18
9. WARRANTY EXCLUSIONS.....	19

1. GENERAL SAFETY INSTRUCTIONS

LEARNING

- Please read the operating instructions carefully. Familiarize yourself with the controls and proper use of the device.
- Never allow children to use the device.
- Never allow persons unfamiliar with the operating instructions to operate the device.
- Local regulations may restrict the age of the user.
- Never operate the device in the presence of people, especially children, or pets.
- The user is responsible for accidents or risks of accidents to other people or their property.
- Use the lawnmower only for the purpose for which it was designed, namely mowing and collecting grass. Any other use might be dangerous and might damage the machine.

Preparation

- When using the device, dress appropriately, always wear sturdy shoes and long pants.
- Do not operate the device barefoot or with open sandals. Do not wear loose clothes or jewellery. Loose clothing, jewellery or long hair may be caught in moving parts.
- Wear protective glasses during use.
- Wearing a mask is recommended to prevent dust irritation.
- Before use, always perform a visual inspection, especially of the blade, making sure that the screws and knife assembly are neither worn nor damaged. Replace worn or damaged blades and all screws to maintain balance.
- Examine closely the area where you are going to use the mower and remove all objects that could be thrown

- by the machine (stones, twigs, wire, bones etc.).
- Before mowing, install and check the condition of the grass catcher.

WARNINGS AND HAZARDS

- Moisture and electricity do not mix well.
- The handling / connection of the cables should be done in a dry place.
- Use a 30mA residual current device (RCD).
- Always avoid contact between an electrical plug or cable and a wet area (puddle or wet grass)
- The connections between the cables and sockets should be waterproof. Only use the extensions with waterproof sockets by moulding or according to current standards, available on the market.
- Power supply cables should not be of a lower quality than type H05RN-F. H05RR-f.H05WF.H05VVH2-F. For outdoor use, with a minimum cross-section of 1.5 m².
- Attach the cable to its hook before starting the equipment.
- The permanent connection of any electrical device in a building should be performed by a qualified electrician, in accordance with current electrical standards.
- A wrong connection can cause serious injury or death.
 - Before connecting the device, check that the sockets and extension cords are in good condition. Do not use the device if it is damaged or worn.
 - Never use the device if the guards are defective or without safety devices, such as the grass catcher in place.
 - Use only an extension cord attached to a coupler according to IEC 60320-2-3 standard.

Use and operation

- Always direct the cable away from the device.
- Mow in daylight or under adequate artificial light.

- Avoid operating the device on wet grass or in the rain.
- Never run the lawnmower over the power cable.
- When mowing, the cable should always be behind the mower and in the area where the grass has already been cut.
- Use the cable hook to avoid unexpected disconnection of the cable.
- Make sure that the plug is properly inserted and avoid forcing the plug.
- Never pull the lawnmower by its power cable and never pull on the power cable to remove it from the socket.
- Do not expose the cable to heat sources. Do not allow it to come into contact with solvents, oil, fuels or sharp objects.
- If a cable is damaged during use, unplug the plug immediately. **DO NOT TOUCH THE CABLE BEFORE UNPLUGGING THE PLUG.**

Disconnect the device from power sources

- Every time you leave the device
- Before you solve a problem.
- Before checking, cleaning or working on the device.
- If the device starts vibrating abnormally.
- Always be careful to your position on the slopes.
- Mow facing the slopes, never from top to bottom.
- Be extremely careful when changing direction on slopes.
- Do not mow on slopes higher than 20°.
- Walk, never run, never let yourself be pulled by the lawnmower.
- Be extremely careful when pulling the lawnmower towards yourself.
- Stop the engine if you have to tilt the lawnmower to transport it, when passing through areas other than grass, and when transporting it to another area to mow.













- Never operate the lawnmower with defective guards or without safety devices, such as a deflector or grass catcher, which are not in place.
- On trailed or powered models, disengage before starting the engine.
- Turn the engine on with the engine switch on, carefully as instructed, and with your feet well away from the blade.
- Do not tilt the mower when you start the engine.
- Place the engine on a flat surface, without obstacles or excessively high grass.
- Do not place your hands or feet under rotating parts.
- When working on the grass catcher or ejection duct, always switch off the engine.
- Never lift or carry a lawnmower with the engine running.
- Stop the engine and disconnect the power cable:
 - Before performing any work behind the cutting deck or unlocking the blade and before checking, cleaning or working on the lawnmower.
 - After striking a foreign object, stop and disconnect the mower, check for damage and repair before restarting and operating it.
 - If the mower starts to vibrate abnormally, stop the mower, check and eliminate the cause of vibration.
 - When you leave the mower unattended.
- Stop the engine:
 - Every time you remove or replace the grass catcher.
 - Before adjusting the cutting height of the grass.
- When mowing, always keep a safe distance from the rotating blade. This distance corresponds to the length of the handlebar.
- After a failure, immediately stop the engine, do not go on mowing, take the machine to an authorized service

centre and ask for qualified personnel to solve the problem.

Maintenance and storage

- Regular maintenance is essential for safety and to maintain performance levels.
- Check all bolts, nuts and screws to ensure that the device is in good working conditions.
- Inspect the condition of the grass catcher frequently. It should always remain in perfect condition.
- Also inspect the deflector and all protection devices.
- Replace worn or damaged parts
- Use only original accessories and replacement parts.
- Store the device only in a dry place.
- To reduce the risk of fire, remove grass, leaves and excess grease from the mower and especially from the engine.
- Empty, clean the grass catcher and let it dry before storing.
- Periodically check the electrical cables and replace them if they are damaged or if the insulation has been damaged.
- Never touch a poorly insulated cable if it is still connected to the power supply. Unplug the cable from the socket before any intervention.
- Wear sturdy gloves when removing and reassembling the blade.
- Check the balance of the blade after sharpening.
- For safety reasons, do not use the mower with worn cables or damaged parts.
- Parts should be replaced and not repaired.
- Use original spare parts.
- Non-equivalent quality parts can damage the mower and be dangerous to your safety.

Symbols

	<p>Waste from electrical products should not be disposed of with household waste. Please recycle them in the dedicated facilities. Check with your local authority or retailer for information on recycling.</p>
	<p>Use eye protection. Use hearing protection.</p>
	<p>Complies with all regulatory standards in force in the EU country where the product is bought</p>
	<p>Wear sturdy, non-slip shoes.</p>
	<p>Risk of personal injury, death, or damage to the device in case of non-compliance. Read the instructions for use.</p>
	<p>Use of protective gloves.</p>
	<p>Do not expose to rain.</p>
	<p>Risk of splashing; keep people away.</p>
	<p>The blade will continue to rotate for a short time after the engine has stopped. Never grab or carry the mower until the knives have stopped rotating.</p>
	<p>This product is doubly electrically insulated.</p>
	<p>Unplug the device from the mains before servicing. Keep the electrical wire away from sharp blades and other sharp objects.</p>
	<p>Immediately disconnect from the mains if the power cord is damaged.</p>
	<p>Beware of sharp blades. The blades continue rotating after the engine has stopped. Unplug the device from the mains before maintenance, i.e. if the power cord is damaged.</p>



Keep the power cord away from cutting tools.

2. YOUR PRODUCT

Description



- 1. Upper handle
- 2. Lower handle
- 3. Switch box

- 4. Grass collection compartment
- 5. Wheels
- 6. Motor protection

Technical data

Model	HTDE1800-1
Voltage	230-240V~ 50Hz
Power index	1800W
No-load speed	3450min ⁻¹
Cutting height	25-80mm, 5 Positions
Cutting width	420mm
Protection class	II
Degree protection	IPX4
Net weight	13.1 kg
Sound pressure level LpA	81.1 dB(A), k=3dB(A)
Sound power level LwA	94.0 dB(A), K=2.06dB(A)
Guaranteed sound power level LwA	96 db (A)
Vibration value	K=2.75 m/s ² ; k=1.5 m/s ²

3. ASSEMBLY

Preparation

1) Connect lower handles (4) and the housing (7) with supplied clip(1) and fixed parts(2,3,5,6,8) (Fig.1)

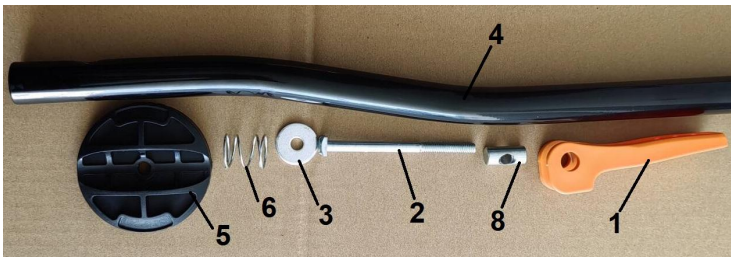

Fig. 1

2) Put the cable hook(1) on upper handle(2) (Fig.2)



Fig. 2

3) Connect upper handle (2) and lower handle (1) with supplied screws(3) , washers (4) and clips(5) (Fig.3)



Fig. 3

4) Fix the cable holders (**Fig.4**)



Fig.4

5) Fit each wheels(2,3,4) over the axles(1) and press the wheel covers (5) into place (**Fig.5**)

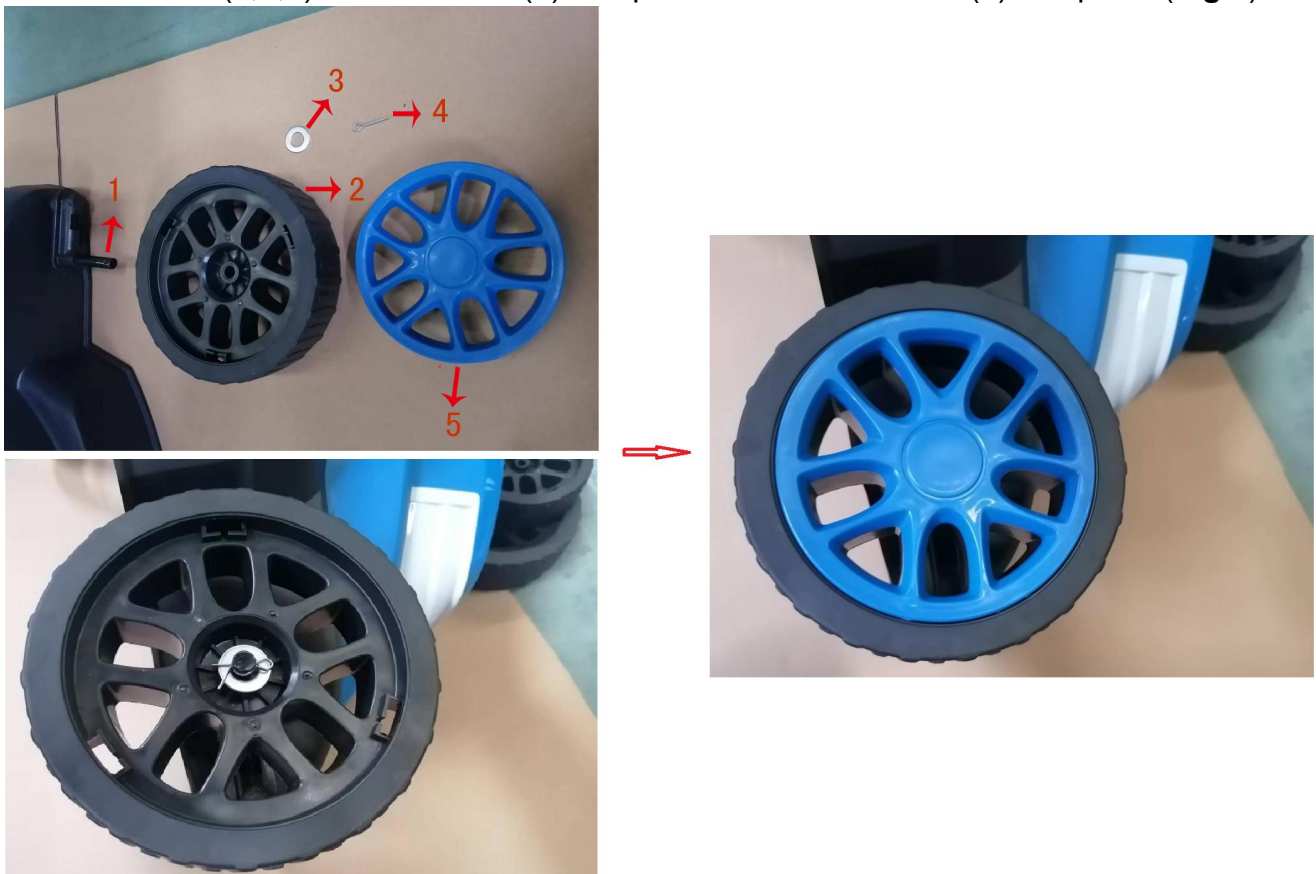

Fig. 5

6) Grass collection box assembly. Assemble two halves (1 and 2) and fix them together with upper cover (3), then fix grass catcher handle(4) on upper cover (**Fig.6**)



Fig.6

7) Lift the flap(1) and place the grass box(3) over the lugs(3) (Fig.7)

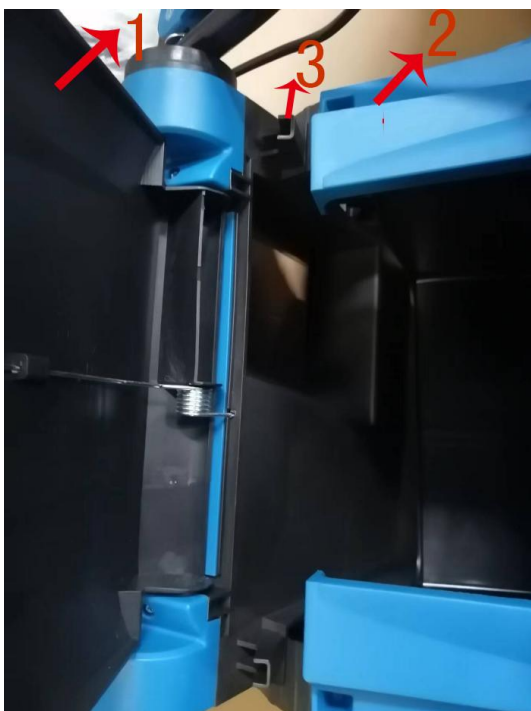

Fig.7

8) Finish assemble (Fig.8)



Fig.8

CUTTING HEIGHT ADJUSTMENT

In order to achieve the desired cutting height, the front and rear axles should be repositioned under the mower frame.

Caution! Disconnect the mower from the area and make sure the blade has stopped rotating before adjusting the height.

Note: Make sure that the right and left rear wheels are adjusted at the same position corresponding to the cutting height.

Cutting height positions (Fig.2c)

- 1) 25mm (lowest cutting height)
- 2) 38mm
- 3) 50mm
- 4) 63mm
- 5) 80mm (highest cutting height)

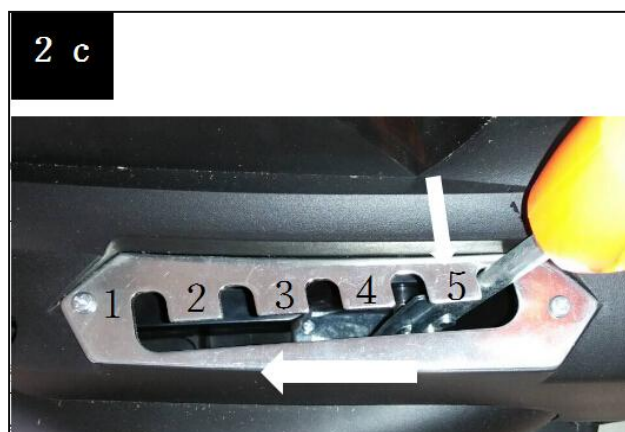

4. OPERATION

⚠ Caution! Before connecting to the mains, always check that the switch is off. Connect the device to an electrical outlet (under RCD network)

Start

On/off switch (Fig. 3C)

Caution! Do not start the mower if the grass on which it is placed is too high. Press the safety button (A) on the switch and pull the safety lever (B) against the bar. Hold the switch lever while you release the safety button. To stop the mower, release the switch lever, which automatically returns to the off position.

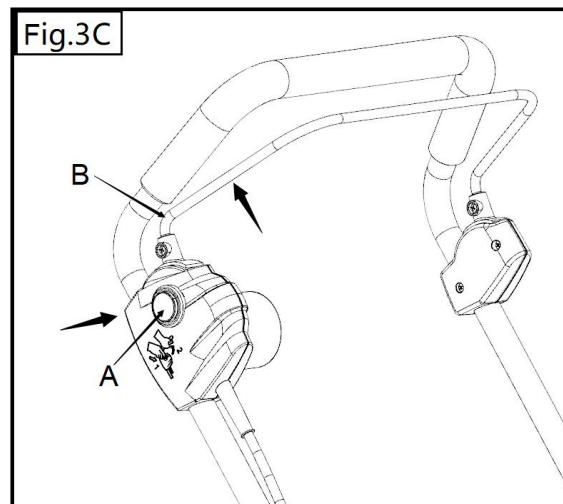

Mowing

We recommend using your lawnmower as described in this section to achieve optimal results and reduce the risk of cutting power cables (Fig. 4C).

- Place the main wiring close to the starting point A.
- Turn on the mower as described above.
- Proceed as described in figure 4 below.
- Change from position A to position B
- Turn right and change to position C.
- Turn left and change to position D.
- Repeat the above processes if needed.

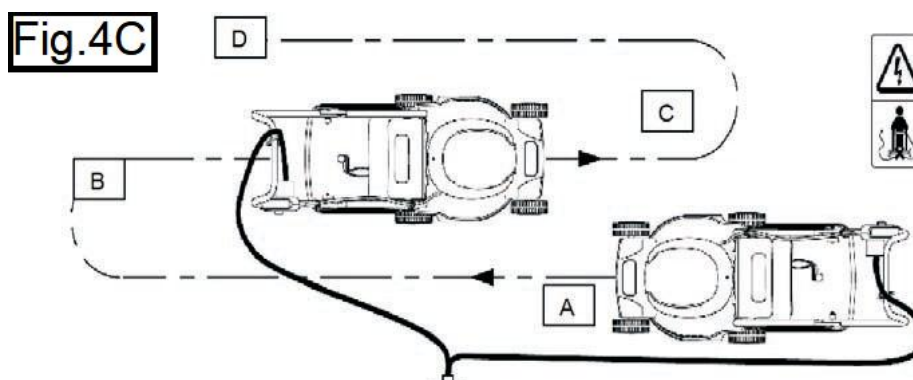

Instructions for the grass catcher

Putting the grass catcher in place: Lift the deflector and place the grass catcher on the tabs.

Emptying the grass catcher: Before working on the grass catcher, switch off the engine and wait for the blade to fully stop.

When you see the grass scattering underneath the mowers, empty the grass catcher. However, never use the device without the grass catcher.

If you need to tighten the cutting blade, first make sure that your mower is not connected to a power supply, then as shown in the diagrams below, use a screwdriver to lock the pin, then use a wrench to tighten the blade.

Caution! Avoid working towards the cable.

5. MAINTENANCE AND STORAGE

1. Keep all nuts, bolts and screws firmly tightened to ensure that the mower can operate safely.
2. Check the mower deck and grass catcher frequently and make sure they are not worn or damaged.
3. Replace worn or damaged parts for your safety.
4. Be sure to use only the replacement blade, its nut and wrench specific for this product.
5. Be careful when adjusting the mower to prevent your fingers from getting caught between the moving blade and fixed parts of the machine.
6. Lubricate the wheel axles.
7. Store the mower in a dry place.
8. Do not wash the mower with plenty of water, wipe it with a dry cloth. Do not spray water or liquid on the engine and electrical components (switch, extension cord, plugs, etc.).

Blade maintenance

1. Remove grass and dirt from the blade regularly.
2. At the beginning of the gardening season, carefully examine the condition of the blade.
3. If the blade is very blunt, sharpen or replace it.
4. If the blade is damaged or worn, replace it.

Caution! Observe the following precautions:

5. Disconnect the mower from the area and wait until the blade has stopped rotating before proceeding.
6. Be careful not to cut yourself. Use strong work gloves or a cloth to grasp the blade.
7. Make sure to use only the specified replacement blade.
8. Do not remove the blade (A) under any circumstances.

Replacing the blade

1. Put the machine on its side.
2. Place the ring on the engine shaft.
3. Place the blade, screw and spring washer.
4. Position the blade on the centring devices.

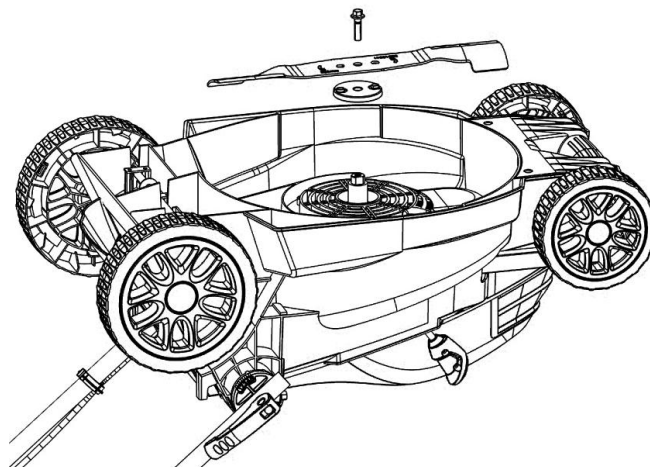

6. DECLARATION OF CONFORMITY



BUILDER SAS

32 rue Aristide Bergès - Z.I. du Casque - 31270 Cugnaux - France

Declares that the machinery designated below:

ELECTRIC MOWER

HTDE1800-1

Serial number: 20240201157-20240201276

**Complies with the provisions of the Directive "machinery" 2006/42/EC and regulations
National transposing it;**

Also complies with the following European directives:

EMC Directive 2014/30/EU

Noise Directive: 2000/14 / EC + Annex VI & 2005/88 / EC

Guaranteed sound power: 96 dB(A)

Sound power: 94 dB(A) K=2.06 dB(A)

RoHS Directive (EU)2015/863 amending 2011/65/EU

**Also complies with European standards, national standards and provisions following
techniques:**

EN 60335-1:2012/A15:2021

EN 60335-2-77:2010

EN IEC 55014-1 :2021

EN IEC 55014-2 :2021

EN IEC 61000-3-2 :2019/A1:2021

EN 61000-3-3:2013/A2:2021

**Certified body of the noise directive: TÜV SÜD Industrie Service GmbH, Westendstraße 199
80686 MÜNCHEN (Germany) Noise test code: 0036**

Done at Cugnaux, 18/01/2024

Philippe MARIE / CEO

7. WARRANTY

HYUNDAI

WARRANTY

The manufacturer guarantees the product against defects in material and workmanship for a period of 2 years from the date of the original purchase. The warranty only applies if the product is for household use. The warranty does not cover breakdowns due to normal wear and tear.

The manufacturer agrees to replace parts identified as defective by the designated distributor. The manufacturer does not accept responsibility for the replacement of the machine, in whole or in part, and/or ensuing damage.

The warranty does not cover breakdowns due to:

- insufficient maintenance.
- abnormal assembly, adjustment or operations of the product.
- parts subject to normal wear and tear.

The warranty does not extend to:

- shipping and packaging costs.
- using the tool for a purpose other than that for which it was designed.
- the use and maintenance of the machine done in a manner not described in the user manual.

Due to our policy of continuous product improvement, we reserve the right to alter or change specifications without notice. Consequently, the product may be different from the information contained therein, but a modification will be undertaken without notice if it is recognized as an improvement of the preceding characteristic.

READ THE MANUAL CAREFULLY BEFORE USING THE MACHINE.

When ordering spare parts, please indicate the part number or code, you can find this in the spare parts list in this manual. Keep the purchase receipt; without it, the warranty is invalid. To help you with your product, we invite you to contact us by phone or via our website:

- **+33 (0)9.70.75.30.30**
- **<https://services.swap-europe.com/contact>**

You must create a "ticket" via the web platform.

- Register or create your account.
- Indicate the reference of the tool.
- Choose the subject of your request.
- Describe your problem.
- Attach these files: invoice or sales receipt, photo of the identification plate (serial number), photo of the part you need (for example: pins on the transformer plug which are broken).



8. PRODUCT FAILURE

WHAT TO DO IF MY MACHINE BREAKS DOWN?

If you bought your product in a store:

- a) Empty the fuel tank if your product has one.
- b) Make sure that your machine is complete with all accessories supplied, and clean! If this is not the case, the repairer will refuse the machine.

Go to the store with the complete machine and with the receipt or invoice.

If you bought your product on a website:

- a) Empty the fuel tank if your product has one..
- b) Make sure that your machine is complete with all accessories supplied, and clean! If this is not the case, the repairer will refuse the machine.
- c) Create a SWAP-Europe service ticket on the site: <https://services.swap-europe.com> When making the request on SWAP-Europe, you must attach the invoice and the photo of the nameplate (serial number).
- d) Contact the repair station to make sure it is available before dropping off the machine.

Go to the repair station with the complete machine packed, accompanied by the purchase invoice and the station support sheet downloadable after the service request is completed on the SWAP-Europe site

For machines with engine failure from manufacturers BRIGGS & STRATTON, HONDA and RATO, please refer to the following instructions.

Repairs will be done by approved engine manufacturers of these manufacturers, see their site:

- <http://www.briggsandstratton.com/eu/fr>
- <http://www.honda-engines-eu.com/fr/service-network-page;jsessionid=5EE8456CF39CD572AA2AEEDFD290CDAE>
- <https://www.rato-europe.com/it/service-network>

Please keep your original packaging to allow for after-sales service returns or pack your machine with a similar cardboard box of the same dimensions.

For any question concerning our after-sales service you can make a request on our website <https://services.swap-europe.com>

Our hotline remains available at +33 (9) 70 75 30 30.



9. WARRANTY EXCLUSIONS

THE WARRANTY DOES NOT COVER:

- Start-up and setting up of the product.
- Damage resulting from normal wear and tear of the product.
- Damage resulting from improper use of the product.
- Damage resulting from assembly or start-up not in accordance with the user manual.
- Breakdowns related to carburetion beyond 90 days and fouling of carburetors.
- Periodic and standard maintenance events.
- Actions of modification and dismantling that directly void the warranty.
- Products whose original authentication marking (brand, serial number) has been degraded, altered or withdrawn.
- Replacement of consumables.
- The use of non-original parts.
- Breakage of parts following impacts or projections.
- Accessories breakdowns.
- Defects and their consequences linked to any external cause.
- Loss of components and loss due to insufficient screwing.
- Cutting components and any damage related to the loosening of parts.
- Overload or overheating.
- Poor power supply quality: faulty voltage, voltage error, etc.
- Damages resulting from the deprivation of enjoyment of the product during the time necessary for repairs and more generally the costs related to the immobilization of the product.
- The costs of a second opinion established by a third party following an estimate by a SWAP-Europe repair station
- The use of a product which would show a defect or a breakage which was not the subject of an immediate report and/or repair with the services of SWAP-Europe.
- Deterioration linked to transport and storage*.
- Launchers beyond 90 days.
- Oil, petrol, grease.
- Damages related to the use of non-compliant fuels or lubricants.

* In accordance with transport legislation, damage related to transport must be declared to carriers within 48 hours maximum after observation by registered letter with acknowledgement of receipt.

This document is a supplement to your notice, a non-exhaustive list.

Attention: all orders must be checked in the presence of the delivery person. In case of refusal by the delivery person, it you must simply refuse the delivery and notify your refusal.

Reminder: the reserves do not exclude the notification by registered letter with acknowledgement within 72 hours.

Information: Thermal devices must be wintered each season (service available on the SWAP-Europe site). Batteries must be charged before being stored.

HYUNDAI

POWER PRODUCTS



GENUINE PRODUCT OF
HYUNDAI CORPORATION

For inquiries, please contact:

BUILDER SAS

32 rue Aristide Bergès - Z.I. du Casque - 31270 Cugnaux - France

Tél.: +33(0)5.34.502.502 Fax.: +33(0)5.34.502.503

<http://www.hyundaipower-fr.com/>

Fabriqué en République Populaire de Chine(PRC)